

VG 425 211 CN (JZT-VG425211CN)

Gas hob
嵌入式燃气灶

Table of contents

Intended use	3
Important safety information	4
Causes of damage	6
Environmental protection	6
Saving energy	6
Environmentally-friendly disposal	6
Familiarising yourself with your appliance	7
Gas hob	7
Control knob	7
Visual signals of the luminous disc	7
Installation accessories	8
Special accessories	8
Individual parts of the burners	8
Operating the appliance	9
Switching on	9
Simmer setting	9
Electronic flame monitoring and automatic re-ignition	9
Switching off	9
Residual heat indicator	9
Safety shut-off	9
Table of settings and tips	10
Tips for cooking and roasting	10
Information and tips regarding cookware	11
Suitable cooking vessels	11
Precautions for use	11
Cleaning and maintenance	12
Cleaning the appliance	12
Burnt-on dirt	12
Burner discolouration	12
Trouble shooting	13
Demo mode	14
After-sales service	15
E number and FD number	15

Additional information on products, accessories, replacement parts and services can be found at www.gaggenau.com and in the online shop www.gaggenau.com/zz/store

Intended use

Read these instructions carefully. Only then will you be able to operate your appliance safely and correctly. Retain the instruction manual and installation instructions for future use or for subsequent owners.

This appliance is only intended to be fully fitted in a kitchen. Observe the special installation instructions.

This appliance must be installed according to the installation instructions included.

Check the appliance for damage after unpacking it. Do not connect the appliance if it has been damaged in transport.

Only allow a licensed professional to connect the appliance. Damage caused by incorrect connection is not covered under warranty. Call the after-sales service if you want to convert your appliance to a different type of gas.

This appliance is intended for domestic use and the household environment only. This appliance must only be used to prepare food and drinks and must never be used as a heater. Do not leave the appliance unattended during operation. Only use the appliance indoors.

Do not install this appliance on boats or in vehicles.

This appliance is intended for use up to a maximum height of 2000 metres above sea level.

This appliance is not intended for operation with an external clock timer or a remote control.

Do not use covers. These can cause accidents, for example due to overheating, catching fire or materials shattering.

Only use safety devices or child protection grilles approved by ourselves. Unsuitable safety devices or child protection grilles may result in accidents.

This appliance may be used by children over the age of 8 years old and by persons with reduced physical, sensory or mental capabilities or by persons with a lack of experience or knowledge if they are supervised or are instructed by a person responsible for their safety how to use the appliance safely and have understood the associated hazards.

Children must not play with, on, or around the appliance. Children must not clean the appliance or carry out general maintenance unless they are at least 15 years old and are being supervised.

Keep children below the age of 8 years old at a safe distance from the appliance and power cable.

Close the safety valve on the gas supply line if the cooker will not be used for a prolonged period.

⚠ Important safety information

⚠ Warning – WHAT TO DO IF YOU SMELL GAS!

Escaping gas may cause an explosion.

If you smell gas or notice any faults in the gas installation:

- Immediately shut off the gas supply or close the gas cylinder valve.
- Immediately extinguish all naked flames and cigarettes.
- Do not use any light or appliance switches and do not pull any plugs out of sockets. Do not use any telephones or mobile phones within the building.
- Open windows and ventilate the room.
- Call the after-sales service or the gas supplier.

⚠ Warning – Risk of asphyxiation!

The use of a gas cooker leads to a build-up of heat, moisture and products of combustion in the room where the appliance is installed. Ensure that the installation room is well ventilated. The natural ventilation openings must be kept open or a mechanical ventilation device must be provided (e.g. an extractor hood). Intensive and persistent use of the appliance may mean that it is necessary to have additional ventilation (e.g. opening a window), or more effective ventilation (e.g. operating the existing mechanical ventilation device at a higher setting).

⚠ Warning – Risk of fire!

- Hot oil and fat can ignite very quickly. Never leave hot fat or oil unattended. Never use water to put out burning oil or fat. Switch off the hotplate. Extinguish flames carefully using a lid, fire blanket or something similar.
- The hotplates become very hot. Never place combustible items on the hob. Never place objects on the hob.
- The appliance becomes very hot and flammable materials could catch fire. Never store or use flammable objects (e.g. spray cans, cleaning agents) under the appliance or in its immediate vicinity. Never place flammable items on or in the appliance.
- When gas hotplates are in operation without any cookware placed on them, they can build up a lot of heat. The appliance and the extractor hood above it may become damaged or be set on fire. Grease residue in the filter of the extractor hood may ignite. Only operate the gas burners with cookware on them.
- If the burner does not ignite after 15 seconds, switch off the control knob and open the door or window in the room. Wait at least 1 minute before igniting the burner again.

⚠ Warning – Risk of burns!

- The appliance becomes hot during operation. Allow the appliance to cool down before cleaning.
- The hotplates and surrounding area (particularly the hob surround, if fitted) become very hot. Never touch the hot surfaces. Keep children at a safe distance.
- The accessible parts become very hot when in operation. Never touch hot parts. Keep children at a safe distance.
- When the appliance cover is closed, heat will accumulate. Only close the appliance cover when the appliance has cooled down. Never switch the appliance on with the appliance cover closed. Do not rest food on the appliance cover or use it to keep food warm.
- Empty cookware becomes extremely hot when set on a gas hotplate that is in operation. Never heat up empty cookware.
- If the liquefied gas bottle is not upright, liquefied propane/butane can enter the appliance. Intense darting flames may therefore escape from the burners. Components may become damaged and start to leak over time so that gas escapes uncontrollably. Both can cause burns. Always use liquefied gas bottles in an upright position.

⚠ Warning – Risk of injury!

- Incorrect repairs are dangerous. Repairs may only be carried out, and damaged power and gas lines replaced, by an after-sales engineer trained by us. If the appliance is faulty, unplug the mains plug or switch off the fuse in the fuse box. Shut off the gas supply. Contact the after-sales service.
- Faults or damage to the appliance are dangerous. Never switch on a faulty appliance. Unplug the appliance from the mains or switch off the circuit breaker in the fuse box. Shut off the gas supply. Contact the after-sales service.
- Unsuitable pan sizes, damaged or incorrectly positioned pans can cause serious injury. Observe the instructions which accompany the cookware.

⚠ Warning – Risk of electric shock and serious injury!

- The cable insulation on electrical appliances may melt when touching hot parts of the appliance. Never bring electrical appliance cables into contact with hot parts of the appliance.
- Do not use any high-pressure cleaners or steam cleaners, which can result in an electric shock.
- A defective appliance may cause electric shock. Never switch on a defective appliance. Unplug the appliance from the mains or switch off the circuit breaker in the fuse box. Contact the after-sales service.
- Incorrect repairs are dangerous. Repairs may only be carried out by one of our trained after-sales engineers. If the appliance is faulty, unplug the mains plug or switch off the fuse in the fuse box. Contact the after-sales service.

Causes of damage

Caution!

- **Risk of heat damage to adjacent appliances or kitchen units:** If the appliance is in operation for an extended period, heat and moisture will be generated. Additional ventilation is required. Open the window or switch on an extractor hood that discharges the extracted air and moisture outside the building.
- **Risk of damage to the appliance due to the build-up of heat:** Do not heat roasters, frying pans or grill stones using more than one burner at a time.
- **Malfunction:** Always turn the control knob to the "Off" position when the appliance is not being used.

Environmental protection

The sections below list a number of energy-saving tips and provide information on disposing of your appliance.

Saving energy

- Choose a burner of roughly the same size as your pan. Place the cookware in the middle.
- Use small saucepans for small quantities. Using a large saucepan with little in it consumes a lot of energy.
- Always place suitable lids on saucepans. Cooking without a lid consumes significantly more energy. Use a glass lid so that you can see into the pan without having to lift the lid.
- Cook with only a little water. This will save energy and preserve the vitamins and minerals in vegetables.
- Switch to a lower heat setting in good time. This will save energy.

Environmentally-friendly disposal

Dispose of packaging in an environmentally-friendly manner.



This appliance is labelled in accordance with European Directive 2012/19/EU concerning used electrical and electronic appliances (waste electrical and electronic equipment - WEEE). The guideline determines the framework for the return and recycling of used appliances as applicable throughout the EU.

Familiarising yourself with your appliance

Gas hob

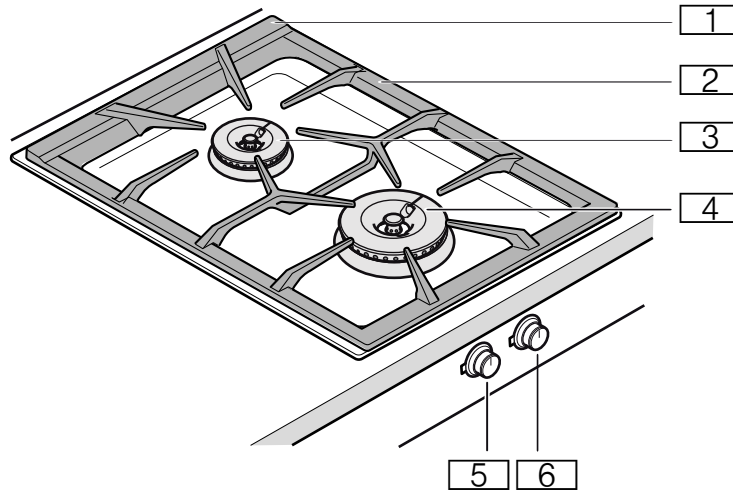

- 1 Ventilation openings (underneath pan support)
- 2 Pan support
- 3 Standard output burner 1.8 kW
- 4 High output burner 3.6 kW
- 5 Control knob, front hotplate
- 6 Control knob, rear hotplate

Control knob

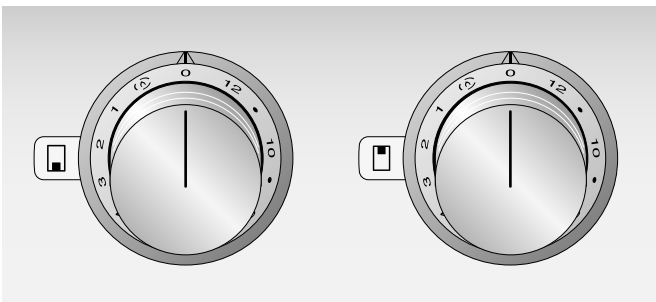

The markings show the position of the corresponding burner and the setting between level 1 to 12 or simmering (🔥).

Visual signals of the luminous disc

The control knob is encircled by an illuminated ring that indicates a number of statuses and functions.

Indicator	Meaning
○ Off	Appliance off
● Lit continuously orange	Appliance on
☀ Flashing orange	Appliance off Residual heat indicator
☀ Flashing orange and white alternately	Safety shut-off, power failure
☀ Flashing yellow and magenta alternately	Appliance fault Call the after-sales service.
● Lit green and then yellow for some seconds	Appliance initialising, only after first installation or power failure

Installation accessories

AA 414 010	Ventilation molding for operation next to downdraft ventilation VL 414
VA 420 000	Connection strip for combination with other Vario 400 appliances for flush installation
VA 420 001	Connection strip for combination with other Vario 400 appliances for flush installation with appliance cover/extension
VA 420 010	Connection strip for combination with other Vario 400 appliances for surface installation
VA 420 011	Connection strip for combination with other Vario 400 appliances for surface installation with appliance cover/extension
VA 440 010	Stainless steel appliance cover
VA 450 401	Appliance extension, 38 cm

Special accessories

You can order the following special accessories from your specialist dealer:

AA 414 010	Ventilation molding for operation next to downdraft ventilation VL 414
------------	--

Only use the accessories as specified. The manufacturer accepts no liability if these accessories are used incorrectly.

Individual parts of the burners

Ensure that the individual parts of the burners are fitted in the correct position and are straight; otherwise, this may result in ignition problems or problems during operation.

Fit the burner head and the burner ring in such a way that the latches on the lower section of the burner click into place in the corresponding slots. The alignment of the burner head and the burner ring is not important.

Note: If the burner parts are fitted at an angle, the appliance will not work.

Individual parts of the standard output burner and high output burner

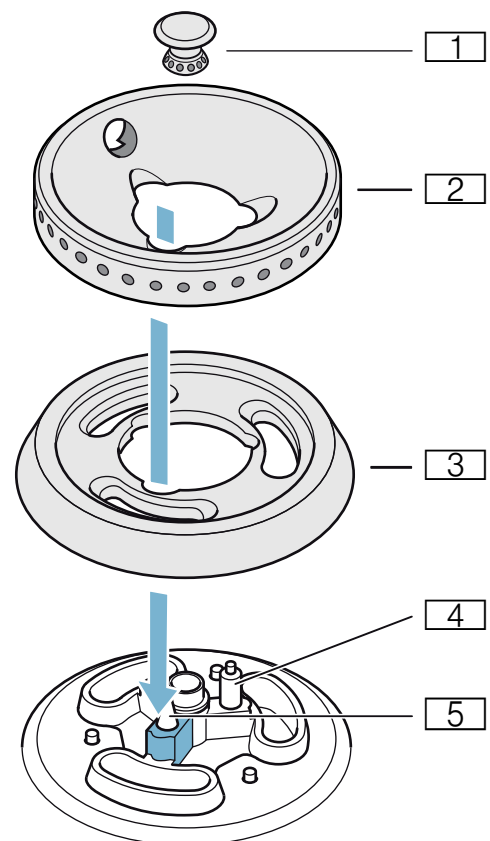

- 1 Burner cap
- 2 Burner ring
- 3 Burner head
- 4 Ignition plug
- 5 Thermocouple

Operating the appliance

Notes

- Only use the accessories specified. Do not line the stainless steel recess (e.g. with aluminium foil).
- The burner and ignition plug must be clean and dry.
- Only light the hotplates if the pan supports and all burner parts are correctly fitted.
- When one burner is ignited, an ignition spark will also be generated at all the other burners.
- Do not touch the ignition plug while the gas appliance is being lit.
- It is important to keep the appliance clean. If the ignition plugs are dirty, this may cause ignition problems. Clean the ignition plugs regularly with a small, non-metallic brush. Take care to prevent the ignition plugs from suffering any heavy knocks.
- When you switch from setting 3 to setting 4 or higher, the burner will briefly switch to its maximum output. This is to optimise ignition between the burner rings.
- Do not cover the ventilation openings on the rear of the gas hob.
- When the gas cooktop is switched on, the electronics open up the gas supply, which produces a short sound. This is normal.
- In the event of a power failure, the appliance will not work. The gas supply is shut off.

Switching on

Your gas hob has an automatic quick-ignition function.

- 1 Place a suitable item of cookware on the pan support.
- 2 Push in the control knob for your chosen burner and turn it clockwise or anti-clockwise to the heat setting you require.
The burner ignites automatically.

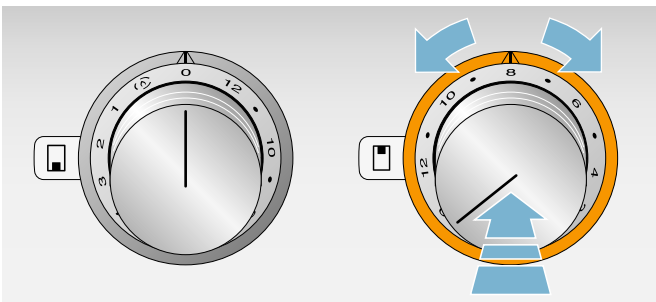

Turn the control knob to set the heat setting.

⚠ Warning – Risk of deflagration!

If the burner does not ignite after 15 seconds, switch off the control knob and open the door or window in the room. Wait at least 1 minute before igniting the burner again.

Simmer setting

With the simmer setting, the burner switches the gas flame on and off. This allows you to melt chocolate or heat up delicate sauces, for example.

Turn the control knob to (D). It takes 10 - 50 seconds to switch on or off.

Electronic flame monitoring and automatic re-ignition

For your safety, the hob has an electronic flame monitoring system. If the flame goes out while the hob is in use (e.g. due to a draught), the appliance will automatically re-ignite the burner.

If re-ignition is unsuccessful (e.g. because liquid or food has boiled over and remains on the burner), the appliance will switch off the gas supply. The illuminated ring behind the control knob will flash.

Turn the control knob to 0. Wait until the appliance is cool enough and then check whether all the burner parts are in the correct position. Check whether the burner or the ignition plug are covered in food remnants etc. → "Trouble shooting" on page 13

Switching off

Turn the control knob to position 0. The appliance electronics will shut off the gas supply.

⚠ Warning – Risk of burns!

When the appliance cover is closed, heat will accumulate. Only close the appliance cover when the appliance has cooled down. Never switch the appliance on with the appliance cover closed. Do not rest food on the appliance cover or use it to keep food warm.

Residual heat indicator

The luminous disc behind the control knob flashes after switching off, to indicate that the appliance has still not cooled down to such an extent that it can be touched safely.

Safety shut-off

For your safety, the appliance has a safety shut-off function. The appliance is automatically switched off if it has been in operation for an extended period. How long the appliance waits before switching itself off depends on the setting (setting 12 = 1 hour, setting 1 = 4 hours). The illuminated ring behind the control knob will flash orange and white alternately.

Turn the control knob to 0. You will now be able to start the appliance again as usual.

Table of settings and tips

Heat setting	Cooking method	Examples
12	Heating	Water, clear soups
	Blanching	Vegetables
10-12	Searing	Meat, wok dishes/ pan-fried dishes
	Frying at high temperatures	Meat, potatoes
7-10	Simmering with the lid open	Liquids, dough-based foods
6-8	Baking	Flour-based food
	Frying at medium temperatures	Poultry, fish
4-6	Frying at low temperatures	Fried sausages, onions, egg dishes
	Warming	Vegetables, soups, stews
	Deep-frying	Chips, pastries
	Poaching with the lid open	Dumplings, boiled sausages
3-4	Defrosting	Frozen food
	Braising	Beef olives, joints
	Stewing	Vegetables
2-4	Simmering with the lid on	Soups, vegetables
Simmer setting – up to 3	Soaking	Rice, rice pudding, cereals
Simmer setting	Melting, keeping warm	Chocolate, butter

Tips for cooking and roasting

The values given in the settings table must be looked upon as recommended values. The heat required depends not only on the type and condition of the food, but also the size and contents of the pot.

Due to the high performance of the cooktop, fat and oil will heat up quickly. Never leave the cooktop unattended, fat can ignite, food can burn.

Preferably use the rear cooking zones to prepare meals, that need longer to cook.

Preferably use the high output burners for brief cooking, deep fat frying and searing of large quantities.

Information and tips regarding cookware

The following information and tips have been provided to help you save energy and avoid damaging your cookware.

Suitable cooking vessels

Burner	Recommended pan base diameter	Minimum pan base diameter
Standard-output burner	200 - 240 mm	90 mm
High-output burner	240 - 280 mm	90 mm

Pans with a diameter of less than 90 mm or more than 280 mm should not be used. If you do use larger pans, these should not protrude beyond the edges of the appliance.

Precautions for use

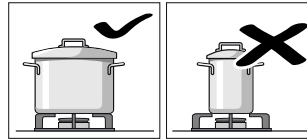

Use pots or pans which are the right size for each burner.

Do not use small pots or pans on large burners. The flame should not touch the sides of the pot.

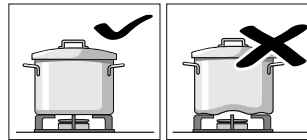

Do not use damaged pots or pans, which do not sit evenly on the cooktop, they may tip over.

Only use pots or pans with a thick, flat base.

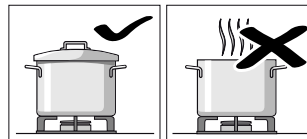

Do not cook without using a lid and make sure the lid is properly fitted. This wastes energy.

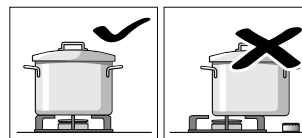

Always centre the pot or pan over the burner, otherwise it could tip over.

Do not place large pots on the burners near the control knobs. These may get damaged by the high temperatures.

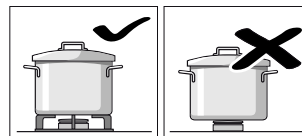

Place the pots or pans on the pan support, never directly on the burner.

Make sure that the pan supports and burner caps are correctly positioned before using the appliance.

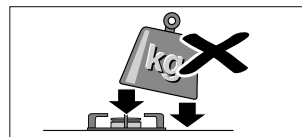

Pots or pans should be placed on the cooktop carefully.

Do not strike the cooktop and do not place excessive weight on it.

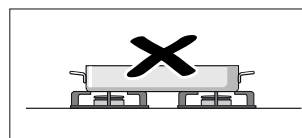

Do not heat a cooking vessel (e.g. roaster, pan, grill stone) on more than one burner at the same time. The resulting heat accumulation will damage the appliance.

Cleaning and maintenance

⚠ Warning – Risk of electric shock!

Do not use any high-pressure cleaners or steam cleaners, which can result in an electric shock.

⚠ Warning – Risk of burns!

The accessible parts become very hot when in operation. Never touch hot parts. Keep children at a safe distance.

Caution!

Risk of surface damage

Do not use these cleaners

- harsh or abrasive cleaning agents
- oven cleaners
- corrosive or aggressive cleaners, or those containing chlorine
- cleaning agents with a high alcohol content
- hard and scratchy sponges, brushes or scouring pads

If such an agent comes into contact with the appliance, wash it off immediately with water.

Thoroughly wash out new sponge cloths before using them!

Cleaning the appliance

Clean the appliance after each use once it has cooled down. Remove spilt liquids immediately and do not allow any food remains to burn on.

Make sure that the ventilation openings under the pan support are always clean. The ventilation openings must not be covered.

Dry the burners thoroughly after cleaning. Only operate the appliance when the burners are dry. Damp burners can cause ignition problems and/or an unstable flame.

During assembly, make sure that the burner parts (catch tappets) are in the correct position. All parts must be straight.

Appliance part/surface	Recommended cleaning
Stainless steel surfaces	Use soapy water and dry with a soft cloth. Only use a minimal amount of water when cleaning so that no water enters the appliance. Soak burnt-on remains with a small amount of soapy water; do not scour. Remove heavy soiling or yellow discoloration caused by heat using our stainless steel cleaning agent (item no. 00311499).
Pan supports, wok ring	Carefully remove them for cleaning. Soak in the sink. Clean using a scrubbing brush and detergent. Clean the area around the rubber buffers carefully so that they do not become detached. Rinse with clean water before leaving to dry. Do not clean them in the dishwasher.
Burner parts	Use soapy water and dry with a soft cloth. Make sure that the openings are not blocked. Take care that no small parts are lost. Do not clean them in the dishwasher.
Control knob	The soapy cloth must not be too wet. Dry with a soft cloth.

Burnt-on dirt

For hard-to-remove, burnt-on dirt, you can order a cleaning gel from our online shop, from your specialist retailer or our after-sales service (item number 00311859). It is suitable for pan supports and the stainless-steel recess. If necessary, let the dirt soak overnight. Follow the instructions on the cleaning agent.

Caution!

Damage to the surface

Do not use the cleaning gel on the burner parts.

Burner discolouration

After extended use, the brass burner parts take on a darker colour as a result of the oxidation process that occurs naturally. The discolouration does not affect their serviceability.

Trouble shooting

Malfunctions often have simple explanations. Please read the following notes before calling the after-sales service.

Warning – Risk of electric shock!

Incorrect repairs are dangerous. Repairs may only be carried out by one of our trained after-sales engineers. If the appliance is faulty, unplug the mains plug or switch off the fuse in the fuse box. Contact the after-sales service.

Disruption	Possible cause	Solution
The burner will not ignite when it is switched on.	Power supply disconnected.	Turn all control knobs to 0. Check the fuse box to see whether the circuit breaker has tripped.
The burner will not ignite when it is switched on. The illuminated ring behind the control knob is flashing orange and white alternately.	Burner or gas supply fault.	Turn all control knobs to 0. Check: <ul style="list-style-type: none"> ● Are the burner parts positioned correctly? ● Is the main gas tap open? ● Is the burner clean and dry? ● Is there air in the line following initial connection or a cylinder change (in the case of liquid gas)? ● Is the gas cylinder empty (in the case of liquid gas)?
The burner will not ignite when it is switched on. All the illuminated rings behind the control knobs are lit white for 10 seconds after switch-on. Then the illuminated ring around the active control knob is lit orange.	Demo mode is activated.	Deactivate demo mode.
The burner will not ignite when it is switched on. The illuminated ring behind the control knob is flashing yellow and magenta alternately.	Electronics fault	Turn all control knobs to 0 and disconnect the appliance from the mains power supply for one minute (switch off the circuit breaker or pull out the plug). Reconnect the appliance. The illuminated rings around the control knobs will be lit green for a few seconds and then turn yellow. Wait until the illuminated rings switch off. Then turn any of the control knobs to any of the heat settings and then back to 0. Switch on the burner. If the illuminated ring starts flashing yellow and magenta again, call our after-sales service.
The burner goes out while the appliance is in operation. The illuminated ring behind the control knob is flashing orange and white alternately.	Safety switch-off function: No actions have been performed for an extended period.	Turn all control knobs to 0, and then switch them back on if you wish to continue using the appliance.
The burner goes out while the appliance is in operation. The illuminated ring behind the control knob is flashing orange and white alternately.	Domestic power failure: Following a power failure, the appliance will remain switched off for safety reasons.	Turn all control knobs to 0, and then switch them back on if you wish to continue using the appliance.
There is a smell of gas in the kitchen.	Gas may be leaking out where the gas cylinder is connected.	Check that the gas cylinder connection is not leaking. Open windows and ensure the room is well ventilated.

The appliance panelling becomes slightly raised at the corners when it is in operation.	The metal from which the cooktop is made expands as it heats up.	This is normal. It will contract again once it has cooled down.
---	--	---

Notes

- Each time the mains power is switched on or following a power failure, a sound is produced when the gas valves are started up. The illuminated rings around the control knobs will be lit green for a few seconds and then turn yellow. Wait until the illuminated rings switch off.
- When the gas cooktop is switched on, the electronics open up the gas supply, which produces a short sound. A sound can also be heard when the setting is changed. This is normal.

Demo mode

The demo mode is activated if all of the illuminated rings around the control knobs light up white for 10 seconds after switching on the appliance. The burner does not ignite. The illuminated ring around the active control knob lights up orange.

You can deactivate the demo mode as follows:

- 1 Turn all of the control knobs to 0. Disconnect the appliance from the mains power supply. Wait at least 30 seconds.
- 2 Reconnect the appliance. The illuminated rings around the control knobs light up green for a few seconds and then turn yellow. Wait until the illuminated rings switch off.
- 3 Then deactivate demo mode within three minutes as follows:
Turn any of the control knobs anti-clockwise to position 12.
- 4 Turn the control knob clockwise to position 1.
- 5 Turn the control knob anti-clockwise to position 0. Wait until the illuminated ring lights up yellow.
- 6 Turn the control knob clockwise to position 1. The illuminated ring lights up green.
Wait for five seconds. The illuminated ring now turns yellow.

Demo mode has now been deactivated. **To save the setting, always exit the menu as follows:**

- 7 Turn the control knob to 0. Then turn the control knob anti-clockwise to position 12. Turn the control knob clockwise to position 1. Turn the control knob anti-clockwise to position 0. Wait until the illuminated ring goes out.

After-sales service

Our after-sales service is there for you if your appliance needs to be repaired. We will always find an appropriate solution, also in order to avoid after-sales personnel having to make unnecessary visits.

E number and FD number

When calling us, please quote the full product number (E no.) and the production number (FD no.) so that we can provide you with the correct advice. The rating plate that features these numbers can be found on the underside of the appliance.

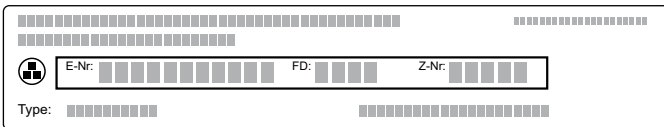

To save time, you can make a note of the numbers for your appliance and the telephone number of the after-sales service in the space below in case you need them.

E no.

FD no.

After-sales service ☎

Please note that a visit from an after-sales service engineer is not free of charge in the event that the appliance has been misused, even during the warranty period.

Please find the contact data of all countries in the enclosed customer service list.

To book an engineer visit and product advice

GB 0344 892 8988
Calls charged at local or mobile rate.

IE 01450 2655
0.03 € per minute at peak.
Off peak 0.0088 € per minute.

AU 1300 368 339

NZ 09 477 0492

Trust the expertise of the manufacturer, and rest assured that the repair will be carried out by trained service technicians using original spare parts for your domestic appliance.

目录

主要用途	17
重要安全信息	18
损坏原因	19
环境保护	19
节能	19
环保处置	19
充分了解您的电器	20
燃气灶	20
控制旋钮	20
照明盘的可见信号	20
安装附件	21
专用附件	21
单个燃烧器部件	21
操作电器	22
开启	22
炖设置	22
电子火焰监控装置和自动再点火功能	22
关断	22
余热指示器	22
安全关机	22
设定表和提示	23
烹饪和烧烤提示	23
关于烹饪容器的信息和提示	23
适合的烹饪器皿	23
使用预防措施	23
清洁和维护	24
清洁电器	24
燃烧灰尘	24
燃烧器褪色	24
出现故障时的操作	25
演示模式	26
售后服务	26
E 编号和 FD 编号	26

更多产品、附件、更换部件以及服务信息请参见
www.gaggenau.com 以及在线商店
www.gaggenau.com/zz/store

主要用途

请认真阅读本手册。只有这样才能安全正确地使用电器。请保管好说明手册和安装说明，以备日后使用或供下一任所有者使用。

本电器仅适合整体安装在厨房内。请遵守专用的安装说明。

必须根据随附的安装说明安装本电器。

拆包后请检查电器是否有损坏。如果电器在运输过程中损坏，请勿连接电器。

只能由持有上岗证书的专业人员连接电器。因不正确连接导致的损坏将不予保修。如果想为电器改接其他燃气类型，请致电售后服务部门。

本电器仅供家庭及家庭型环境使用。本电器仅可用于烹饪食物和饮品，切勿用作加热器。切勿在无人看管时让本电器保持运行。本电器仅限室内使用。

不要将本电器安装在船上或车辆中。

本电器最高可在海拔 2000 米的高度使用。

本电器不适合用外部定时器或遥控器操作。

切勿使用盖子。这会由于过热、起火或材料粉碎等原因引发事故。

只能使用我们许可使用的安全设备或儿童安全烤架。不合适的安全设备或儿童安全烤架可能导致事故。

8 岁以上儿童以及身体、感官或精神有缺陷的人员或缺乏经验和知识的人员，必须在有人监督的情况下或在其安全责任人给予电器使用安全指导并了解相关危险的情况下，方可使用本电器。

严禁儿童玩耍本电器及在电器周围玩耍。儿童除非年满 15 岁并有人监督，否则不得清洁本电器或执行一般维护操作。

8 岁以下儿童请远离本电器和电源线。

如果燃气灶长时间不使用，请关闭供气管道上的安全阀门。

⚠ 重要安全信息

⚠ 警告 – 闻到泄漏燃气时应如何处理！

泄漏的燃气可能引起爆炸。

当您闻到泄漏的燃气或注意到燃气安装存在问题时：

- 请立即关闭供气管路或气罐阀门。
- 立即熄灭所有明火和香烟。
- 请勿使用任何照明或电器开关，也不要将任何插头从插座中拔出。请勿在建筑物内使用电话或手机。
- 打开窗户给房间通风。
- 请致电售后服务部门或燃气供应商。

⚠ 警告 – 窒息危险！

使用燃气灶会导致热量、水汽和燃烧产物在本电器的安装室内积聚。确保本电器安装室通风良好。务必保持自然通风孔畅通或使用机械通风设备（例如吸油烟机）。如果长时间密集地使用本电器，则需要另外进行通风（例如打开窗户），或进行更有效的通风（例如将现有的机械通风设备调至高排风档位）。

⚠ 警告 – 有着火危险！！

- 热的油着火速度极快。切勿让油在无人监管的情况下烧至灼热。切勿用水扑灭燃烧的油。关断电磁灶头。使用盖子、灭火毯或类似工具小心扑灭火焰。
- 电磁灶头变得很热。切勿将易燃物品放在电磁灶台上。切勿将物品放在电磁灶台上。
- 电器变得灼热，易燃材料可能会着火。不得在电器下面或其附近存放或使用易燃物品（例如喷雾罐、清洁剂等）。不得将易燃物品放在电器上或电器中。
- 如果燃气灶头点燃，而灶头上未放置任何炊具，可能会积聚大量热量。电器或安装在电器上方的吸油烟机可能会损坏或着火。吸油烟机的油脂过滤器中的油脂残留物可能会着火。使用燃气型燃烧器时，务必在燃烧器上放置炊具。
- 如果在 15 秒后，燃烧器仍未点燃，请关闭控制旋钮，然后房间内的门或窗。至少等待 1 分钟再进行燃烧器点火。

⚠ 警告 – 有灼伤危险！

- 电器在操作过程中会变热。请等电器冷却后再进行清洁。
- 电磁灶头及周围区域，尤其是电磁灶台外缘会变得很热。切勿触碰灼热表面。请将小孩留在安全距离以外。
- 可触及部件在电器运转时会变得灼热。切勿触碰灼热部件。请将小孩留在安全距离以外。
- 当盖上电器盖时，热量会蓄积。只有在电器冷却之后才能盖上电器盖。切勿在盖上电器盖时开启电器。不要将食物放在电器盖上或用电器盖保温食物。
- 放置在点燃的燃气灶头上的空炊具会变得极烫。请勿加热空炊具。
- 如果液化气罐倾斜放置，液化丙烷 / 丁烷可能会流入电器。可能因此从燃烧器漏出急促猛烈的火焰。这样可能会损坏组件，并且随时间慢慢泄漏，会导致燃气泄漏不可控。这两种情况都会导致燃烧。使用液化罐时，始终保持其处于直立位置。

⚠ 警告 – 有受伤危险！

- 修理不当是很危险的。只能由经过我们培训的售后服务人员维修电器、更换损坏的电源线和管路。如果电器有故障，拔下电源插头或断开保险丝盒中的保险丝。关断气源。联系售后服务部门。
- 发生故障及损坏的电器是非常危险的。请勿开启有故障的电器。拔下电器的电源插头或断开保险丝盒中的断路器。关断气源。联系售后服务部门。
- 锅具尺寸不适合、损坏或位置不当可能会导致严重受伤。请遵守炊具随附的说明书。

⚠ 警告 – 有电击及严重受伤危险！

- 如果接触到电器的灼热部件，电器的电线绝缘层会熔化。切勿使电器电源线接触电器的灼热部件。
- 请勿使用高压清洁器或蒸汽清洁器，以防触电。
- 故障电器会导致电击危险。切勿接通发生故障的电器。拔下电器的电源插头或断开保险丝盒中的断路器。联系售后服务部门。
- 修理不当是很危险的。只能由我公司派出的经过培训的售后工程师进行修理。如果电器有故障，拔下电源插头或断开保险丝盒中的保险丝。联系售后服务部门。

注意：如果电源软线损坏，为避免危险，必须由制造厂或其维修部或类似的专职人员来更换。

主要技术参数：

额定电压范围： 220V~

额定频率： 50Hz

额定热负荷： 5400W

原产地： 法国

总经销商： 博西家用电器（中国）有限公司

地址： 南京市中山路 129 号中南国际大厦
20、21 楼

执行标准：

GB 4706.1-2005

家用和类似用途电器的安全 第 1 部分：通用要求

GB 16410-2007

家用燃气灶具

损坏原因

注意！

- **对相邻电器或橱柜的热损坏危险：**如果电器长期处于操作状态，则会产生热量和水汽。需要另外通风。打开窗，或打开吸油烟机，将产生的气体和水汽排出屋外。
- **热量的蓄积会导出电器出现损坏危险：**不要同时使用多个燃烧器加热烧烤盘、煎锅或烤石。
- **功能故障：**电器不用时，一定要将控制旋钮转至“关断”位置。

环境保护

下面列出一些节能提示，并且提供电器处理的相关信息。

节能

- 选择与您的烤盘大小相仿的燃烧器。将烹饪容器放在中间。
- 食物少则使用小号锅具。使用大号锅具烹饪少量食物会耗费大量能源。
- 一定要为锅具盖上合适的盖子。烹饪时不使用锅盖会明显消耗更多能源。使用玻璃锅盖，则无需打开锅盖就能看到锅内的烹饪状况。
- 仅使用很少量的水烹饪，这不仅节约能量，而且能保存蔬菜自身的所有维生素和矿物质。
- 及时切换至较低的温度设置。这样能节省电能。

环保处置

本电器根据有关废弃电气和电子设备 — WEEE 的欧洲指令 2012/19/EG 进行标识。该指令规定了在欧盟范围内有效地回收和再利用旧电器的框架。

充分了解您的电器

燃气灶

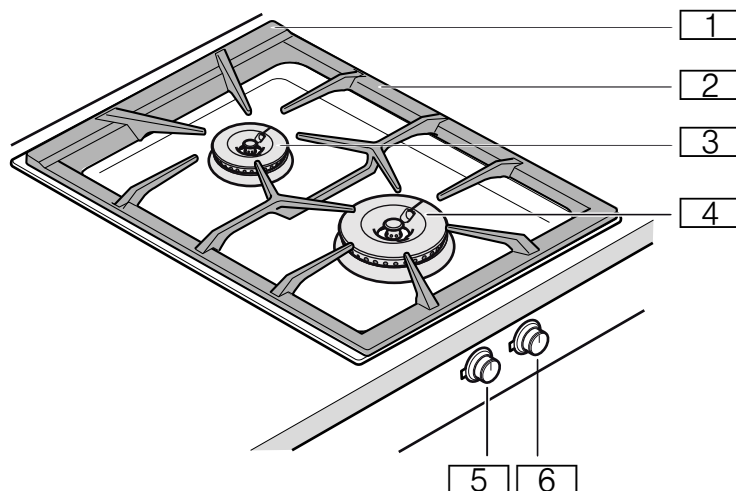

- 1 通风口 (锅架下面)
- 2 锅架
- 3 标准炉头 1.8 kW
- 4 大功率燃烧器 3.6 kW
- 5 控制旋钮、前灶头
- 6 控制旋钮、后灶头

控制旋钮

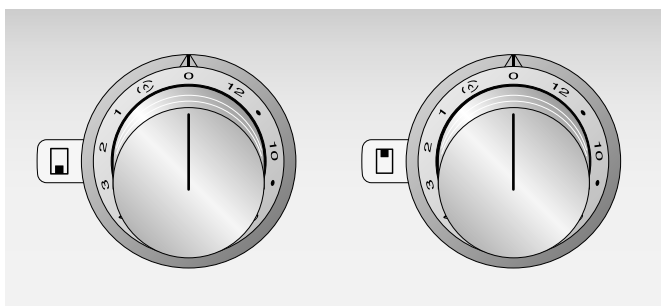

指示标记表示相应的燃烧器位置，以及从 1 至 12 的火力等级或文火煨 (🔥)。

照明盘的可见信号

控制旋钮四周有一个光圈，指示一些状态和功能。

指示符	含义
○ 关	电器断开
● 常亮橙色	电器通电
☀ 闪烁橙色	电器断开 余热指示器
☀ 交替闪烁橙色和白色	安全关闭、电源故障
☀ 交替闪烁黄色和洋红色	电器故障 致电售后服务部门。
● 在几秒钟内先亮绿色、再亮黄色	电器初始化， 仅在首次安装或电源故障后进行

安装附件

- AA 414 010 适用于在下排式吸油烟机 VL 414 旁边使用的通风嵌条
- VA 420 000 连接条，用于与其他 Vario 400 电器组合进行齐平安装
- VA 420 001 连接条，用于与其他 Vario 400 电器组合，实现带电器盖或延长件的齐平安装
- VA 420 010 连接条，用于与其他 Vario 400 电器组合，实现表面安装
- VA 420 011 连接条，用于与其他 Vario 400 电器组合，实现带电器盖或延长件的表面安装
- VA 440 010 不锈钢电器盖
- VA 450 401 电器延长线，38 cm

专用附件

可以从专业经销商处订购以下专用附件：

- AA 414 010 适用于在下排式吸油烟机 VL 414 旁边使用的通风嵌条

仅可使用专用附件。因错误使用附件造成的问题，生产厂商概不负责。

单个燃烧器部件

确保燃烧器各部件的安装位置正确、无倾斜；否则，会导致出现点火问题或在操作期间出现问题。

安装燃烧器头和燃烧器环时，应使燃烧器下方的锁扣卡入相应的槽中。燃烧器头和燃烧器环是否对准并不重要。

提示：如果燃烧器部件安装不正，电器可能无法工作。

标准炉头和超大火炉头的单个部件

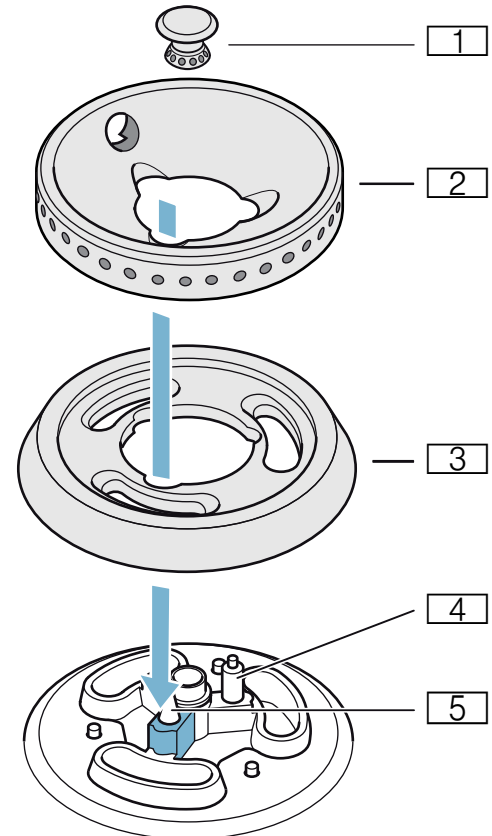

- 1 炉头火盖
- 2 外环火盖
- 3 燃烧头
- 4 点火塞
- 5 热电偶

操作电器

提示

- 仅使用规定的附件。不要遮盖不锈钢凹槽 (例如, 用铝箔纸)。
- 燃烧器和点火塞必须干净并且干燥。
- 只有在正确装配所有锅架和燃烧器部件之后才能进行电灶头点火。
- 当点燃一个燃烧器后, 其他燃烧器也会产生火花。
- 当燃气电器已经点燃后, 不要触摸点火塞。
- 保持电器清洁非常重要。如果点火塞很脏, 可能会导致点火故障。用小的非金属刷定期清洁点火塞。注意防止点火塞遭受猛烈碰撞。
- 从设置 3 切换为设置 4 后, 燃烧器会短暂地切换到最大输出。这是为了优化燃烧器环之间的点火。
- 不要遮住燃气灶后面的通风孔。
- 燃气灶打开后, 电子器件会打开供气管路, 您会听见轻微的开启声音。这是正常现象。
- 如果出现电源故障, 电器不会工作。气源会关断。

开启

您的燃气灶具有自动快速点火功能。

- 1 将合适的烹饪容器放在锅架上。
- 2 按下所选择的燃烧器的控制旋钮, 顺时针或逆时针转动至所需加热设置。
燃烧器自动点火。

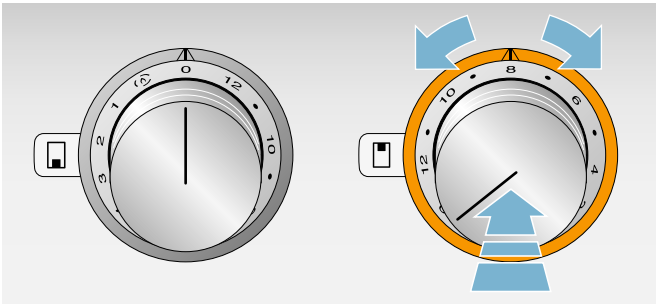

旋转控制旋钮, 设置加热设置。

⚠ 警告 – 爆燃危险!

如果在 15 秒后, 燃烧器仍未点燃, 请关闭控制旋钮, 然后房间内的门或窗。至少等待 1 分钟再进行燃烧器点火。

炖设置

使用炖设置, 燃烧器会开关燃气火焰。这可以让您融化巧克力或加热精美调味汁等。

将控制旋转到 (🕒)。10-50 秒内会接通或断开。

电子火焰监控装置和自动再点火功能

因安全原因, 电磁灶台设有电子火焰监控功能。如果在电磁灶台使用过程中火焰熄灭 (由于气流), 电器会自动重新点火燃烧器。

如果重新点火失败 (例如, 由于液体或食物沸溢, 导致燃烧器上留有残渣), 电器则会关断气源。控制旋钮后面的照明盘将闪烁。

将控制旋钮转至位置 0。待电器完全冷却后, 检查所有燃烧器部件的装配位置是否正确。检查燃烧器或点火塞上是否有食物残渣等。→ "出现故障时的操作" 第 25 页

关断

将控制旋钮转至位置 0。电器电子器件会关闭供气管路。

⚠ 警告 – 有灼伤危险!

当盖上电器盖时, 热量会蓄积。只有在电器冷却之后才能盖上电器盖。切勿在盖上电器盖时开启电器。不要将食物放在电器盖上或用电器盖保温食物。

余热指示器

控制旋钮后面的照明盘在关断之后闪烁, 表示电器仍然没有冷却至可以安全触摸的程度。

安全关机

基于安全考虑, 电器具有安全自动关机功能。如果电器处于操作状态的时间过长, 电器会自动关闭。导致电器自动关机的持续工作时长取决于电器设置 (设置 12 = 1 小时, 设置 1 = 4 小时)。控制旋钮后面的照明盘将交替闪烁橘色和白色。

将控制旋钮转至位置 0。现在可以正常再次启动电器。

设定表和提示

加热设置	烹饪方法	示例:
12	加热	水、清汤
	汆烫	蔬菜
10-12	烧煎	肉, 炒锅 / 煎锅
	高温油炸	肉、土豆
7-10	锅具开盖文火煨	汁液、面团食物
6-8	烘焙	面粉类食物
	中温油炸	家禽、鱼类
4-6	低温油炸	炸香肠、洋葱、蛋类菜肴
	加热	蔬菜、汤、炖菜
	油炸	薯条、甜点
	水煮, 锅具开盖	饺子、煮香肠
3-4	解冻	冷冻食物
	文火炖	牛肉橄榄、牛肉块
	炖肉	蔬菜
2-4	锅具开盖文火煨	汤、蔬菜
炖设置 - 3	浸泡	米、米饭布丁、谷物
炖设置	融化、保温	黄油、巧克力

烹饪和烧烤提示

设定表内给出的值只能视为推荐值。所需的热量不仅取决于食物的类型和状态，还取决于锅具的大小和容量。

由于灶具性能卓越，油会迅速变热。灶具切不可无人看管，否则，油会着火，食物会烧焦。

最好使用后部烹饪区域烹饪需要较长烹饪时间的食物。

快速烹饪、油炸及烧烤大量食物时，最好使用大功率燃烧器。

关于烹饪容器的信息和提示

下列信息和提示用于帮助您节约能源，避免损坏烹饪容器。

适合的烹饪器皿

燃烧器	推荐的锅底直径	最小的锅底直径
标准燃烧器	200 - 240 mm	90 mm
大功率燃烧器	240 - 280 mm	90 mm

不可使用直径小于 90 mm 或大于 280 mm 的锅。若要使用大型锅，注意锅具不得超出燃气灶边缘。

使用预防措施

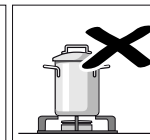
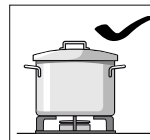

使用适合每个燃烧器尺寸的锅具。

不要在大燃烧器上使用小锅具。火焰不应触及锅具的侧面。

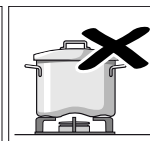
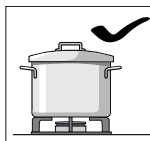

不要使用损坏的锅具，它们不能平稳地放置在灶台上，可能会翻倒。

只能使用底厚且平的锅具。

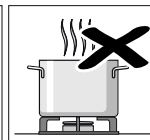
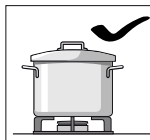

不要不盖盖子烹饪；盖子要盖好，否则会浪费能源。

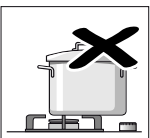
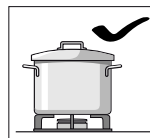

一定要将锅具放在燃烧器中央，否则可能会翻倒。

不要将大型锅具放在靠近控制旋钮的燃烧器上。否则可能会因高温损坏控制旋钮。

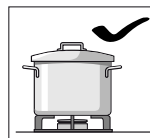

将锅具放在锅架上，切勿直接放在燃烧器上。

在使用本电器之前，一定要保证锅架和火盖位置正确。

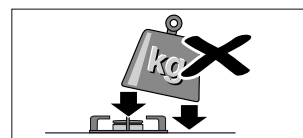

请小心地将锅放在灶具上。

不可撞击灶具，不可在灶具上放过重的物体。

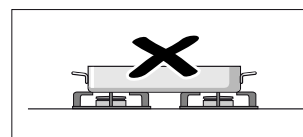

不要同时在一个以上的燃烧器上加热烹饪器皿（如烘焙炉、平底锅、烤石）。否则，产生的热量积聚会损坏电器。

清洁和维护

⚠ 警告 – 有电击危险！

请勿使用高压清洁剂或蒸汽清洁剂，以防触电。

⚠ 警告 – 有灼伤危险！

可触及部件在电器运转时会变得灼热。切勿触碰灼热部件。请将小孩留在安全距离以外。

注意！

有表面损坏危险

请勿使用以下清洁物品

- 强烈的或腐蚀性的清洁剂
- 烤箱清洁剂
- 腐蚀性的或侵蚀性的清洁剂，或含氯的清洁剂
- 高酒精含量的清洁剂
- 粗糙的硬海绵、刷子或擦洗片

如果此类溶剂接触到本电器，请立即用水清洗掉。

新海绵布使用前要彻底清洗！

清洁电器

每次使用之后，等电器冷却后进行清洁。立即去除沸溢的液体，不要让任何食物残留物烧干。

确保锅架下的通风槽始终保持清洁。不得遮盖通风槽。

在清洁之后，让燃烧器彻底晾干。只有在燃烧器晾干后才能使用电器。潮湿的燃烧器会导致点火问题和 / 或火焰不稳定。

装配期间，请确保燃烧器部件（锁销）位置正确。所有零件必须竖直定位。

电器部件 / 表面 建议清洁方法

不锈钢表面	<p>使用肥皂水并用软布擦干。清洁时仅需要使用最小量的水，以免水进入电器。</p> <p>用少量的肥皂水浸泡干化的残留物；不要冲刷。</p> <p>使用我们的不锈钢清洁剂（货号 00311499）去除顽固污迹或加热导致的黄斑。</p>
锅架，圆底锅架	<p>小心取下进行清洁。在洗涤槽中浸泡。使用刷子和清洁剂进行清洁。</p> <p>仔细清洁橡胶缓冲器周围的区域，避免使其脱离。</p> <p>干燥前，用清水冲洗。</p> <p>不要用洗碗机清洁。</p>
燃烧器部件	<p>使用肥皂水并用软布擦干。确保通风槽没有堵塞。</p> <p>留意没有缺少任何小部件。</p> <p>不要用洗碗机清洁。</p>
控制旋钮	<p>蘸有肥皂水的湿布不能太湿。用软布擦干。</p>

燃烧灰尘

对于难以去除的燃烧灰尘，您可以从专卖店或我们的售后服务部门订购清洁剂（货号 00311859）。适用于锅架和不锈钢凹槽。如有必要，将污垢浸泡一晚。请遵守清洁剂上的说明。

注意！

表面损坏

请勿在燃烧器部件上使用清洁剂。

燃烧器褪色

超期使用后，由于自然的氧化处理，铜制燃烧器部件颜色会变深。褪色不会对其功用造成影响。

出现故障时的操作

故障通常有简单说明。在给售后服务打电话前，请阅读下面的说明

⚠ 警告 – 有电击危险！

修理不当是很危险的。只能由我公司派出的经过培训的售后工程师进行修理。如果电器有故障，拔下电源插头或断开保险丝盒中的保险丝。联系售后服务部门。

故障	可能的原因	解决方案
开启时燃烧器不点火。	电器电源已断开。	将所有控制旋转变至位置 0。检查保险丝盒，查看断路器是否熔断。
开启时燃烧器不点火。 控制旋钮后面的光圈将交替闪烁橘色和白色。	燃烧器或供气管道故障。	将所有控制旋转变至位置 0。 检查： <ul style="list-style-type: none"> ● 燃烧器部件安装位置是否正确？ ● 主燃气阀门是否处于打开状态？ ● 燃烧器是否干净并且干燥？ ● 初始连接或更换燃气罐后管道中是否有气体（使用液化气的情况下）？ ● 燃气罐是空的（使用液化气的情况下）？
开启时燃烧器不点火。 在开启电器后，控制旋钮后面的所有光圈亮起白色 10 秒。工作控制旋钮周围的光圈亮起橙色。	演示模式已激活。	取消激活演示模式。
开启时燃烧器不点火。 控制旋钮后面的光圈交替闪烁黄色和洋红色。	电子器件故障	将所有控制旋转变至 0，然后断开电器电源一分钟（关断断路器或拔下插头）。 重新连接电器。控制旋钮周围的光圈亮起绿色几秒，然后变为黄色。等待光圈关断。然后将任何控制旋转变至任何加热设置，然后转回 0。 打开燃烧器。如果光圈再次开始闪烁黄色和洋红色，请致电售后服务部门。
电器在操作过程中，燃烧器熄灭。 控制旋钮后面的光圈将交替闪烁橘色和白色。	安全关闭功能： 较长时间内没有执行任何操作。	将所有控制旋钮旋转至位置 0，如果您想要继续使用电器，再将这些旋钮旋转回去。
电器在操作过程中，燃烧器熄灭。 控制旋钮后面的光圈将交替闪烁橘色和白色。	家庭电源故障： 出现电源故障后，出于安全原因，电器将会保持关断状态。	将所有控制旋钮旋转至位置 0，如果您想要继续使用电器，再将这些旋钮旋转回去。
厨房区域有一股燃气味道。	燃气罐连接处可能会出现泄漏。	检查燃气罐连接处是否存在泄漏。打开窗户，确保室内通风良好。
操作过程中，电器镶板在四角处会微微翘起。	灶具的金属材质会在加热时膨胀。	这是正常现象。冷却后，会再次收缩。

提示

- 每次打开电源或出现电源故障后，开启燃气阀门时都会有声音。控制旋钮周围的光圈亮起绿色几秒，然后变为黄色。等待光圈关断。
- 燃气灶打开后，电子器件会打开供气管路，您会听见轻微的开启声音。更改设置时，也会听到声音。这是正常现象。

演示模式

在开启电器后，如果控制旋钮周围的所有光圈亮起白色 10 秒钟，则演示模式被激活。燃烧器不点火。工作控制旋钮周围的光圈亮起。

您可以按照下列步骤取消激活演示模式：

- 1 将控制旋钮转至 0。断开电器电源。至少等待 30 秒钟。
- 2 重新连接电器。控制旋钮周围的光圈亮起绿色几秒，然后变为黄色。等待光圈关断。
- 3 然后按如下步骤在 3 分钟内取消激活演示模式：将任意控制旋钮逆时针转至位置 12。
- 4 将控制旋钮顺时针转至位置 1。
- 5 将控制旋钮逆时针转至位置 0。等待光圈亮起黄色。
- 6 将控制旋钮顺时针转至位置 1。光圈将亮绿光。等待 5 秒钟。光圈现在会变为黄色。

演示模式已取消激活。按照下列步骤退出菜单即可保存设置：

- 7 将控制旋钮转至位置 0。然后将控制旋钮逆时针转至位置 12。将控制旋钮顺时针转至位置 1。然后将控制旋钮逆时针转至位置 0。等待光圈熄灭。

售后服务

如果您的电器需要修理，我们为您提供售后服务。我们会找出合适的解决方法，并尽量避免售后人员不必要的上门服务。

E 编号和 FD 编号

来电时，请提供产品号 (E 编号) 和生产号 (FD 编号)，以便我们为您提供正确的建议。标有这些编号的铭牌位于电器底端。

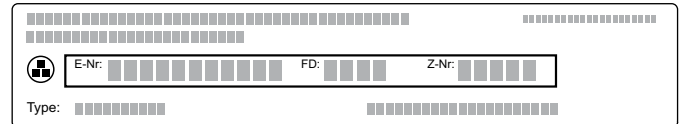

您可以在以下空白处记下电器编号和售后服务部的电话号码，以便在需要这些号码时不用花时间去找。

E 编号

FD 编号

售后服务 ☎

请注意，在误用电器的情况下，即使在保修期内，售后服务技术人员上门服务时也会收取费用。

请在随设备提供的客户服务列表中查找所有国家的联系信息。

预约工程师上门及产品咨询

CN 400 828 0099

呼叫速率取决于所使用的网络上。

制造商的专业水平值得您信赖。因此，将由受过专业训练的技术服务人员使用原装电器零件为您维修。

产品中有害物质的名称及含量

部件名称	有害物质					
	铅 (Pb)	汞 (Hg)	镉 (Cd)	六价铬 (Cr(VI))	多溴联苯 (PBB)	多溴二苯醚 (PBDE)
印制电路组件	×	○	○	○	○	○
显示单元	×	○	○	○	○	○
电源线及连接线	×	○	○	○	○	○
外壳组件	×	○	○	○	○	○
阀体及管路组件	×	○	○	○	○	○
燃烧器组件	×	○	○	○	○	○

本表格依据SJ/T 11364 的规定编制。

○：表示该有害物质在该部件所有均质材料中的含量均在 GB/T 26572 规定的限量要求以下。

×：表示该有害物质至少在该部件的某一均质材料中的含量超出GB/T 26572 规定的限量要求。

注意：上表包含了本公司生产的此类产品的全部部件，本产品的部件以实际配置为准。

如您对此有任何疑问，请拨打本产品所提供的公司客服电话。

产品环保信息提示性说明

请按照产品说明书的要求使用和维护本产品，不当利用或者处置本产品可能会对环境和人类健康造成影响。

依照国家《废弃电器电子产品回收处理条例》的有关规定，当您计划将此产品废弃时，请将其交给具有废弃电器电子产品处理资格的处理企业进行处理。产品中有毒有害物质含量信息参照上表。

Gaggenau Hausgeräte GmbH
Carl-Wery-Straße 34
81739 München
GERMANY
www.gaggenau.com

9001154504 (970701)
en, zh



GAGGENAU